

## 800V N-Channel MOSFET

### General Description

This Power MOSFET is produced using Truesemi's advanced planar stripe DMOS technology. This advanced technology has been especially tailored to minimize on-state resistance, provide superior switching performance, and withstand high energy pulse in the avalanche and commutation mode. These devices are well suited for high efficiency switched mode power supplies, active power factor correction based on half bridge topology.

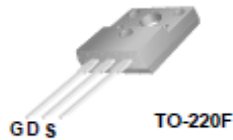

### Features

$V_{DSS}$	$R_{DS(ON)(MAX)}$ $V_{GS}=10V$	$I_D$
800V	1.10Ω	10A

- Low gate charge (typical 45nC)
- High ruggedness
- Fast switching
- 100% avalanche tested
- Improved dv/dt capability

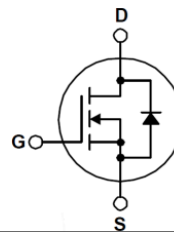

### Absolute Maximum Ratings $T_C=25^\circ C$ unless otherwise specified

Symbol	Parameter	Value	Units
$V_{DSS}$	Drain-Source Voltage	800	V
$V_{GS}$	Gate-Source Voltage	±30	V
$I_D$	Drain Current	$T_C = 25^\circ C$	10.0 A
		$T_C = 100^\circ C$	6.0 A
$I_{DM}$	Pulsed Drain Current (Note 1)	40	A
$E_{AS}$	Single Pulsed Avalanche Energy (Note 2)	920	mJ
$E_{AR}$	Repetitive Avalanche Energy (Note 1)	24	mJ
dv/dt	Peak Diode Recovery dv/dt (Note 3)	4.0	V/ns
$P_D$	Power Dissipation ( $T_C = 25^\circ C$ ) -Derate above $25^\circ C$	240	W
		1.92	W/ $^\circ C$
$T_J, T_{STG}$	Operating and Storage Temperature Range	-55 to +150	$^\circ C$
$T_L$	Maximum lead temperature for soldering purposes, 1/8" from case for 5 seconds	300	$^\circ C$

\* Drain current limited by maximum junction temperature.

### Thermal Resistance Characteristics

Symbol	Parameter	Typ.	Max.	Units
$R_{\theta JC}$	Thermal Resistance, Junction-to-Case	--	0.52	$^\circ C/W$
$R_{\theta CS}$	Thermal Resistance, Case-to-Sink Typ.	0.24	--	$^\circ C/W$
$R_{\theta JA}$	Thermal Resistance, Junction-to-Ambient	--	40	$^\circ C/W$

## Electrical Characteristics $T_C=25\text{ }^\circ\text{C}$ unless otherwise specified

Symbol	Parameter	Test Conditions	Min	Typ	Max	Units
--------	-----------	-----------------	-----	-----	-----	-------

### On Characteristics

$V_{GS}$	Gate Threshold Voltage	$V_{DS} = V_{GS}, I_D = 250\text{ }\mu\text{A}$	3.0	--	5.0	V
$R_{DS(ON)}$	Static Drain-Source On-Resistance	$V_{GS} = 10\text{ V}, I_D = 5.0\text{ A}$	--	0.93	1.10	$\Omega$

### Off Characteristics

$BV_{DSS}$	Drain-Source Breakdown Voltage	$V_{GS} = 0\text{ V}, I_D = 250\text{ }\mu\text{A}$	800	--	--	V
$\Delta BV_{DSS} / \Delta T_J$	Breakdown Voltage Temperature Coefficient	$I_D = 250\text{ }\mu\text{A}$ , Referenced to $25\text{ }^\circ\text{C}$	--	0.99	--	$V/^\circ\text{C}$
$I_{DSS}$	Zero Gate Voltage Drain Current	$V_{DS} = 800\text{ V}, V_{GS} = 0\text{ V}$	--	--	1	$\mu\text{A}$
		$V_{DS} = 640\text{ V}, T_C = 125\text{ }^\circ\text{C}$	--	--	10	$\mu\text{A}$
$I_{GSSF}$	Gate-Body Leakage Current, Forward	$V_{GS} = 30\text{ V}, V_{DS} = 0\text{ V}$	--	--	100	nA
$I_{GSSR}$	Gate-Body Leakage Current, Reverse	$V_{GS} = -30\text{ V}, V_{DS} = 0\text{ V}$	--	--	-100	nA

### Dynamic Characteristics

$C_{iss}$	Input Capacitance	$V_{DS} = 25\text{ V}, V_{GS} = 0\text{ V},$ $f = 1.0\text{ MHz}$	--	2200	--	pF
$C_{oss}$	Output Capacitance		--	180	--	pF
$C_{rss}$	Reverse Transfer Capacitance		--	15	--	pF

### Switching Characteristics

$t_{d(on)}$	Turn-On Time	$V_{DS} = 400\text{ V}, I_D = 10.0\text{ A},$ $R_G = 25\text{ }\Omega$  (Note 4,5)	--	50	--	ns
$t_r$	Turn-On Rise Time		--	130	--	ns
$t_{d(off)}$	Turn-Off Delay Time		--	100	--	ns
$t_f$	Turn-Off Fall Time		--	80	--	ns
$Q_g$	Total Gate Charge	$V_{DS} = 640\text{ V}, I_D = 10.0\text{ A},$ $V_{GS} = 10\text{ V}$  (Note 4,5)	--	45	--	nC
$Q_{gs}$	Gate-Source Charge		--	14	--	nC
$Q_{gd}$	Gate-Drain Charge		--	18	--	nC

### Source-Drain Diode Maximum Ratings and Characteristics

$I_S$	Continuous Source-Drain Diode Forward Current	--	--	10.0	A	
$I_{SM}$	Pulsed Source-Drain Diode Forward Current	--	--	40.0		
$V_{SD}$	Source-Drain Diode Forward Voltage	$I_S = 10.0\text{ A}, V_{GS} = 0\text{ V}$	--	--	1.5	V
$t_{rr}$	Reverse Recovery Time	$I_S = 10.0\text{ A}, V_{GS} = 0\text{ V}$	--	730	--	ns
$Q_{rr}$	Reverse Recovery Charge	$di_F/dt = 100\text{ A}/\mu\text{s}$ (Note 4)	--	11	--	$\mu\text{C}$

#### NOTES:

1. Repetitive Rating: Pulse width limited by maximum junction temperature
2.  $L=17.5\text{ mH}, I_{AS}=10.0\text{ A}, V_{DD}=50\text{ V}, R_G=25\text{ }\Omega$ , Starting  $T_J=25\text{ }^\circ\text{C}$
3.  $I_{SD} \leq 10.0\text{ A}, di/dt \leq 200\text{ A}/\mu\text{s}, V_{DD} \leq BV_{DSS}$ , Starting  $T_J = 25\text{ }^\circ\text{C}$
4. Pulse Test : Pulse width  $\leq 300\text{ }\mu\text{s}$ , Duty cycle  $\leq 2\%$
5. Essentially Independent of Operating Temperature Typical Characteristics

Typical Characteristics

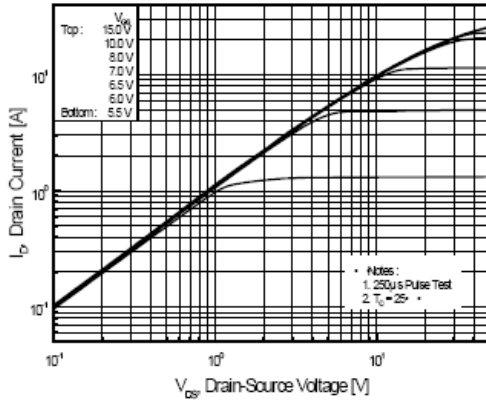

Figure 1. On-Region Characteristics

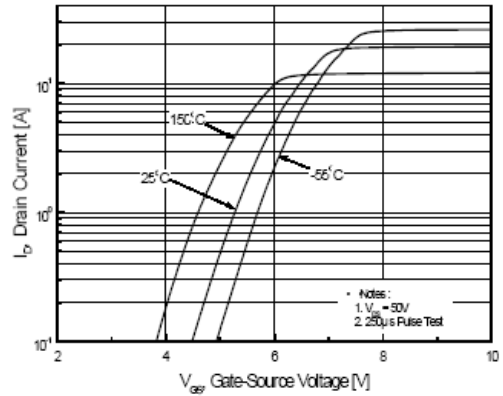

Figure 2. Transfer Characteristics

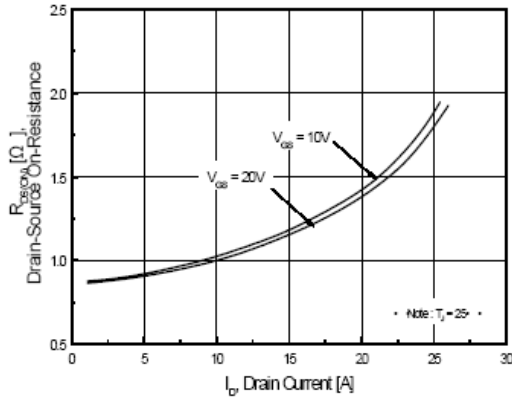

Figure 3. On-Resistance Variation

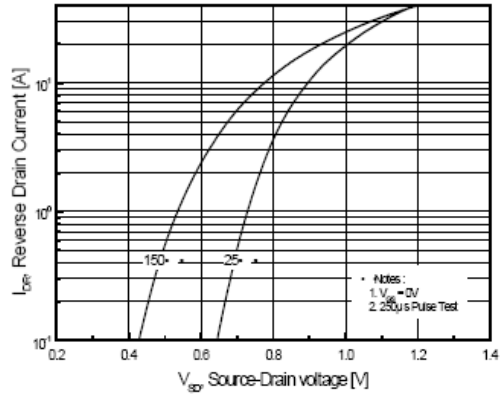

Figure 4. Body Diode Forward Voltage

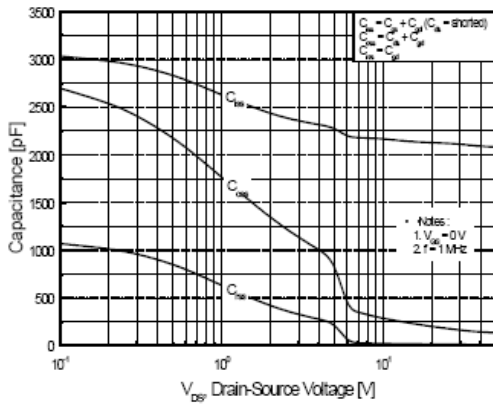

Figure 5. Capacitance Characteristics

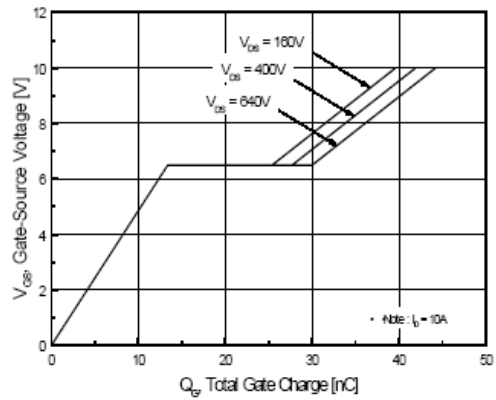

Figure 6. Gate Charge Characteristics

Typical Characteristics

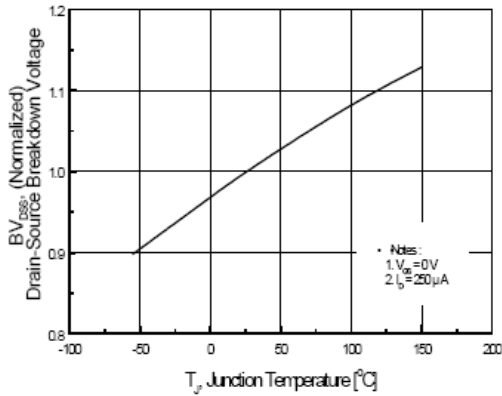

Figure 7. Breakdown Voltage Variation vs Temperature

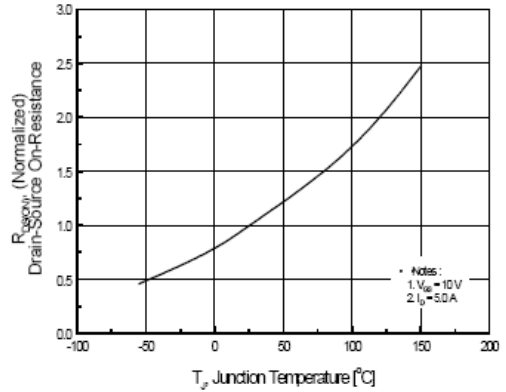

Figure 8. On-Resistance Variation vs Temperature

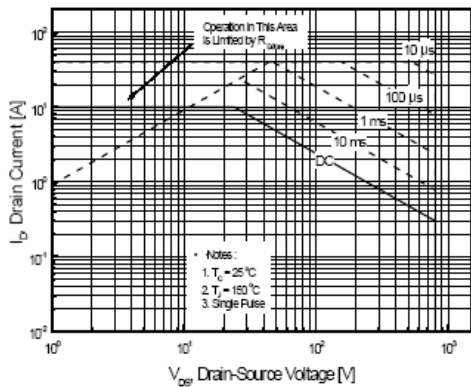

Figure 9. Maximum Safe Operating Area

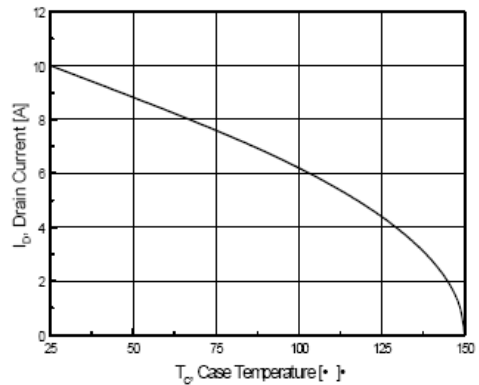

Figure 10. Maximum Drain Current vs Case Temperature

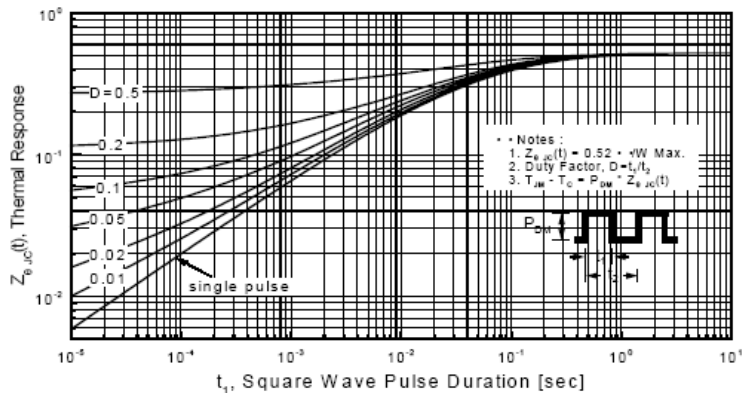

Figure 11. Transient Thermal Response Curve

Fig 12. Gate Charge Test Circuit & Waveform

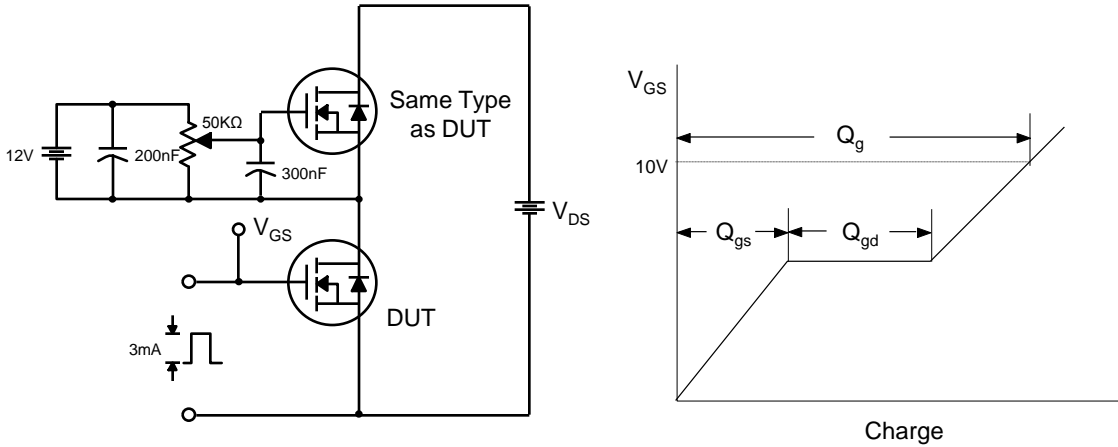

Fig 13. Resistive Switching Test Circuit & Waveforms

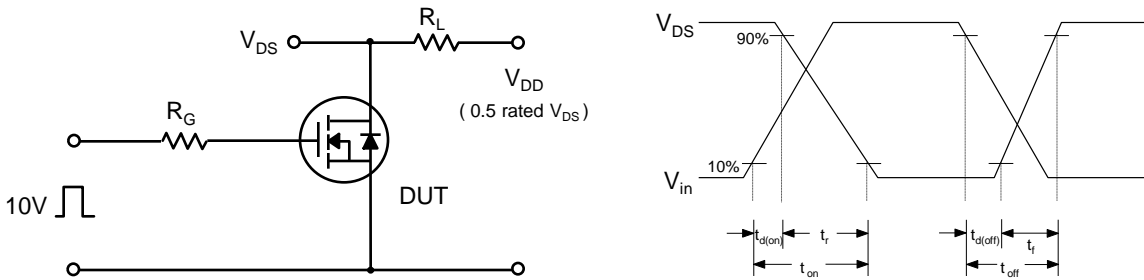

Fig 14. Unclamped Inductive Switching Test Circuit & Waveforms

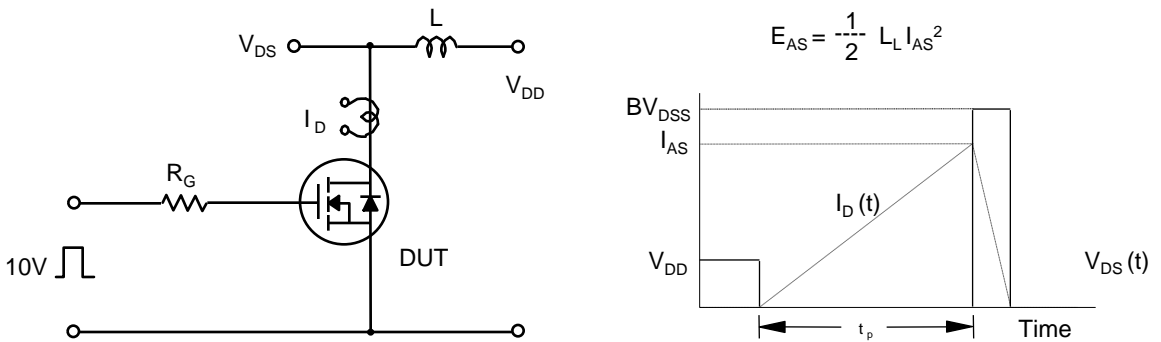

Fig 15. Peak Diode Recovery dv/dt Test Circuit & Waveforms

